

Since 1968

COMMAX
SmartHome & Security

User Manual

Color video door phone CDV-70UX



www.commax.com

COMMAX Co.,Ltd.



- Thank you for purchasing COMMAX products.
- Please carefully read this User's Guide (in particular, precautions for safety) before using a product and follow instructions to use a product exactly.
- The company is not responsible for any safety accidents caused by abnormal operation of the product.



1. Table of Contents

Table of Contents	
2. Safety Warning & Caution	2
3. Start	4
3.1.Part name	4
3.2.Display composition	5
4. Home	6
4.1. Display composition	6
4.2. Door	7
4.3. Call log	7
4.4. Visitor Photo Viewer	7
4.5. Emergency	7
4.6. phone	7
5. Applications	8
5.1. Call	8
5.1.1. Display composition	8
5.1.2. Door	9
5.1.3. Call log	10
5.1.4. Receiving a call from Smartphone	11
5.2. Security	12
5.2.1. Display composition	12
5.2.2. Panic alert	13
5.2.3. Check visitors	14
5.3. Convenient features	16
5.3.1. Display composition	16
5.3.2. Create account	17
5.3.3. Alarm clock	18
5.3.4. Calculator	19
5.3.5. Sound recorder	19
6. Settings	20
6.1. Settings	20
6.2. Password setting	20
6.3. Advanced setting	20
6.4. Wireless network setting	21
6.5. Sound setting	21
6.6. Display setting	22
6.7. Language and keyboard setting	23
6.8. Time and date setting	23
7. Supplement	25
7.1. The package includes the followings.	25
7.2. Specification and Features	25
7.3. Wiring	26
7.4. Caution for cabling	26
7.5. Caution for recoding video of visitors	27
7.6. Connecting via Smartphone	28

2. Safety Warning & Caution

Please follow the things described below in order to prevent any danger or property damage.

	Warning	It may cause a serious damage or injury if violated.		Prohibition.
	Caution	It may cause a minor damage or injury if violated.		No disassembly
				No touch
				Must follow strictly.
				Shows plugging out the power cord without an exception
				Shows the warning and caution for an electric shock.
				Shows the warning and caution for a fire.

Warning

Power & Installation

Please don't use several products at the same time on one power socket.

- It may cause a fire due to an abnormal overheating.

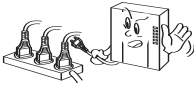

Please don't bend the power cable excessively or it may cause an electric shock.

- fire when using a damaged power cable.

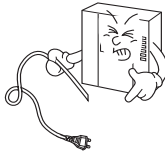

Please don't handle the power cable with a wet hand.

- It may cause an electric shock.

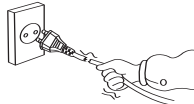

Please plug out the power cable from the socket when not using it for a long period of time.

- It may shorten the product lifespan or cause a fire.

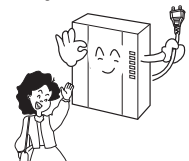

Please don't install the product in the place where there is much oil, smoke or humidity.

- It may cause an electric shock or fire.

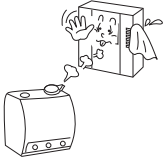

Please don't install the product with the lightning and thunder.

- It may cause an electric shock or fire.

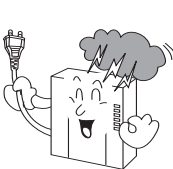

Please don't use and connect this product with other products with different rated voltage.

- It may cause a disorder or fire.

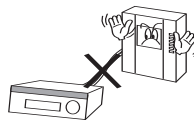

When installing the product that generates heat, please install the product away from the wall (10cm) for the ventilation.

- It may cause a fire due to the increased internal temperature.

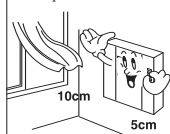

⚠ Warning

Cleaning & Use

Please don't disassemble, repair or rebuild this product arbitrarily (please contact the service center if a repair is needed).

- It may cause an electric shock or fire.

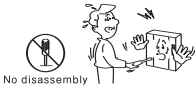

If an abnormal sound, burning smell or smoke is coming out of the product, please plug out the power cable and contact a service center.

- It may cause an electric shock or fire.

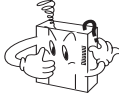

Please don't insert any metallic or burnable materials into the ventilation hole.

- It may cause an electric shock or fire.



Please use only the designated batteries for the products of using DC power.

- It may cause an electric shock or fire.



⚠ Caution

Power & Installation

Please plug the power cable firmly into the inner end.

- It may cause a fire.

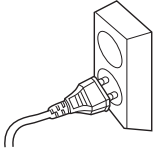

Please hold the plug tightly when unplugging the power cable (a part of the copper wire may be disconnected if the grabbing is only made on the cord when pulling out the cable).

- It may cause an electric shock or fire.



When connecting the power cables after cutting the cable, please install the product with power off.

- It may cause an electric shock or fire.



When installing the product, please fix it firmly while using the wall-mounting unit and screws.

- It may cause an injury from the falling object.

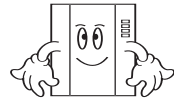

Please be careful when using an AC circuit breaker since there is a possibility of an electric shock.

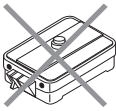

Please check the use voltage and current for the DC-only products and use the appropriate rectifier.

- It may cause a fire.



Please avoid direct rays of the sun or heating devices at a time of installation.

- It may cause a fire.

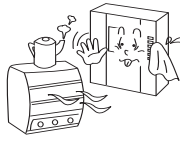

Please don't install the product on an unstable place or small support board.

- It may cause an injury if it falls down while in use.



Cleaning & Use

When cleaning the product, please rub it with a soft and dry cloth after plugging out the power cable. (Please don't use any chemical products such as wax, benzene, alcohol or cleanser.)



Please don't drop the product on the ground and don't apply a shock.

- It may cause a failure.

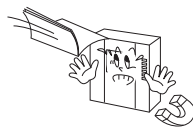

Please use the designated connection cable within the maximum calling distance designated for the product.

- It may reduce the product performance.





3. Start

3.1. Part name

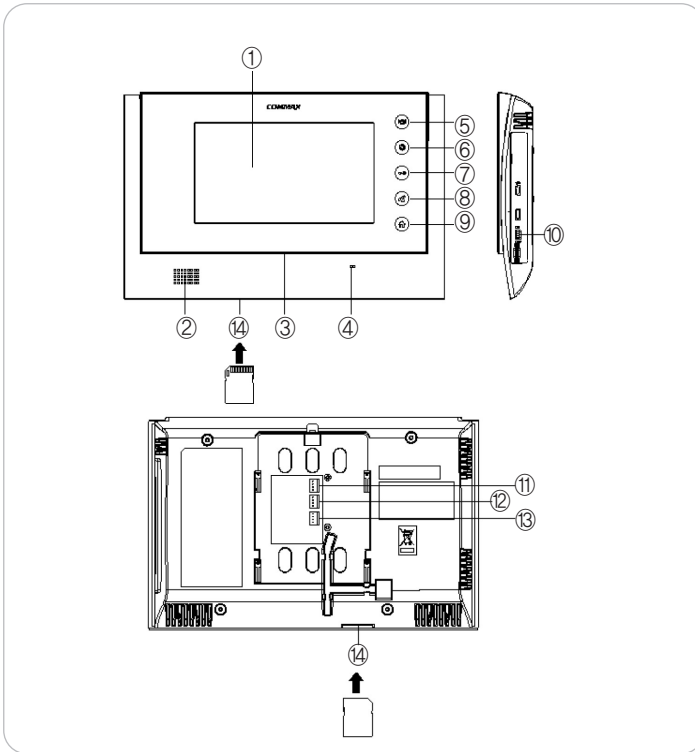



No.	Description	No.	Description
1	Touch screen	8	Call button
2	Speaker	9	Home button
3	Power LED	10	Power switch
4	Microphone	11	Camera 1 connector
5	Panic button	12	Camera 2 connector
6	Page button	13	Interphone connector
7	Door release button	14	SD card slot



3.2. Display composition



Page scrolling enabled





Buttons at the top





	Go to Home
	Volume down
	Volume up

	Other options (background & settings)
	Back

Alert icons

The corresponding icon will be indicated for each alert. Scroll down while touching the top line of alert indication to display the alert detail.

	System activation error.
	System successfully activated
	Call function error
	Call function properly activated
	Wi-Fi





	Panic alert
	Visitor image recorded
	Unanswered call
	Alarm on
	Device connected



4. Home

4.1. Display composition



	Door	Monitoring individual entrance, talking with a visitor, etc.
	Call log	Call log
	Visitor Photo Viewer	Check recorded images of visitors
	Emergency	Panic alert
	phone	Call interphone



4.2. Door

Monitoring individual entrance

- 1) Individual entrance monitoring and talking with a visitor enabled by a touch of 'Individual entrance' button.
- 2) Please refer to section '5.1.2 Individual entrance' for detail.



4.3. Call log

Call log, Call type, Make a call from Call log



- 1) Touch 'Call log' button to view call log list.
- 2) Please refer to section '5.1.3 Call log' for detail



4.4. Visitor Photo Viewer

Check recorded images of visitors

- 1) The latest recorded image is displayed first.

	No images
	New images
	Visitor's image recorded at the individual entrance

- 2) Please refer to section '5.2.3 Visitor' for detail



4.5. Emergency

Panic alert

- 1) Panic alert activated by a touch of 'Panic alert' button
- 2) Please refer to section '5.2.2 Panic' for detail.



4.6. phone

Call interphone

Call an interphone by a touch of 'Interphone' button'





5. Applications

5.1. Call

5.1.1. Display composition



	Door	Monitoring individual entrance, Talking with a visitor, etc.
	phone	Call interphone
	Call log	Call log



- | | |
|-----------------------------|-------------------------|
| ① Activated call indication | ⑦ Capture a video |
| ② Requesting a call | ⑧ Display setting |
| ③ Call | ⑨ Call display |
| ④ End call | ⑩ Volume |
| ⑤ Cancel | ⑪ Recording in progress |
| ⑥ Capture an image | ⑫ Door Open |

- ※ Different 'Call display' is displayed for each type of call.
- ※ Up to 500 images including videos can be stored and automatic overwriting is done from the oldest image or video.



5.1.2. Door

Individual entrance monitoring

Individual monitoring and talking with a visitor

- 1) Touch 'Individual entrance' icon.
- 2) Touch 'Individual entrance' or 'Individual entrance 2' button for monitoring.
- 3) Touch 'Cancel' button to stop monitoring.
- 4) Touch 'Call' button while monitoring to start talking with a visitor.
- 5) Touch 'End call' button to end a call.







Recording visitor's image from individual entrance

- 1) Touch 'Capture an image' button while paging or calling.
- 2) If successfully recorded,  (visitor image recorded) icon is indicated at the top of the display.

Adjusting an image size

- 1) While talking touch  (expand) button to enlarge the image.
- 2) If the expanded image is touched, it goes back to the original size.

Display settings for images from an individual entrance

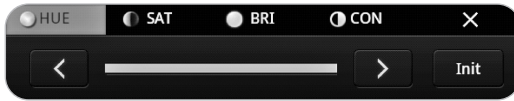

- 1) Touch 'Individual entrance' button.
- 2) Touch  (Display setting) button.
- 3) Touch the following buttons that you wish to set up in the Display settings tab and use the right and left buttons to change the value.
 (Hue),  (Saturation),  (Brightness),  (Contrast)  (Lt.),  (Rt.)
- 4) If you wish to return to default setting, touch 'Default setting' button.

- ※ Display settings for the images from an individual entrance is enabled in monitoring mode of the individual entrance



Individual entrance image display setting

Receiving a call from an individual entrance

- 1) When paged from an entrance, the touch panel rings and displays the visitor.
- 2) To receive a call, touch  (Call) button. To reject a call, touch  (Cancel) button.
- 3) To hang up a call, touch  (End call) button.

Switching channel from an individual entrance to the other.

- 1) While monitoring an entrance touch  (Switch channel) button.
- 2) The current monitoring channel will be switched to the other entrance.



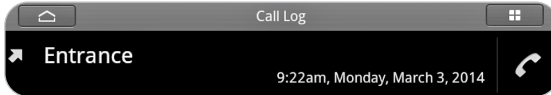

5.1.3. Call log

Call log, Call type, Make a call from Call log



Call log display

Using Call log

- 1) Touch  button to make a call from Call log.
 - 2) Touch  (Other options) button and touch 'Delete' button to delete the call log selected.
- ※ Up to 500 call logs can be stored and the automatic overwriting starts from the oldest log information.



5.1.4. Receiving a call from Smartphone

The call is being forwarded to a registered wireless device.



Display while a call is being forwarded to Smartphone



- 1) Smartphone rings and by a touch of 'Confirm' button visitor's image is displayed.
- 2) To receive a call, touch 'Call' button and touch 'Cancel' button to reject a call.
- 3) To end a call, touch 'End call' button
- 4) As a call is received from Smartphone, the touch panel displays the following message, 'The call is being forwarded to a registered wireless device'.

5.2. Security

5.2.1. Display composition



Security functions

 Panic alert	Panic alert
 Check visitors	Check recorded images of visitors



5.2.2 Panic alert

Panic alert

By touch of 'Panic alert' button, the Panic alert is activated. The Panic alert notice is processed in three steps such as 'On', 'Off', and 'Reset'.

Panic alert on

- 1) Touch 'Panic alert' icon to activate the emergency alert. The touch panel displays the Panic alert icon and sounds a siren.

Panic alert off

- 1) Touch 'Off' button.
- 2) Enter password (default password is '1234'.)

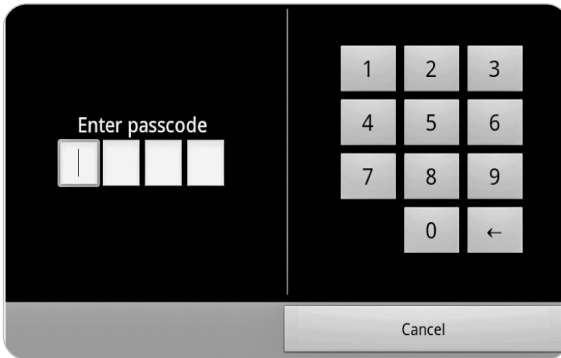

Enter password

Panic alert reset

- 1) If password accepted, the 'Off' button is changed to 'Reset'.
- 2) Touch 'Reset' button.
- 3) The Panic alert is off and reset to normal.



Panic alert reset



5.2.3. Check visitors

Viewing recorded images of visitors from an individual entrance



- ① Menu
- ② Visit location and unanswered call log
- ③ Time of picture taken
- ④ Page information
- ⑤ Previous page
- ⑥ Next page

Touch 'Menu' button to view menu selection

	Select all	Check all images viewed in current display
	Delete	Delete selected images
	Delete all	Delete all recorded images
	Exit	Exit from current menu



Below icons indicate which entrance the images were taken from.

	Individual entrance	Images taken from an individual entrance
--	---------------------	--

Check recorded images

In Check visitors mode, all recorded images from individual entrances can be viewed including time and date information.

Deleting recorded images

- 1) Touch 'Menu (①)' button.
- 2) Touch 'Menu (①)' button or touch an image for 2 seconds or longer to activate 'Select' mode.
- 3) Select an image by a touch or touch  (Select all) button to select images you wish to delete.
- 4) Touch the image once again to unselect.
- 5) Touch  (Delete) button to delete the selected images..

Expanded view



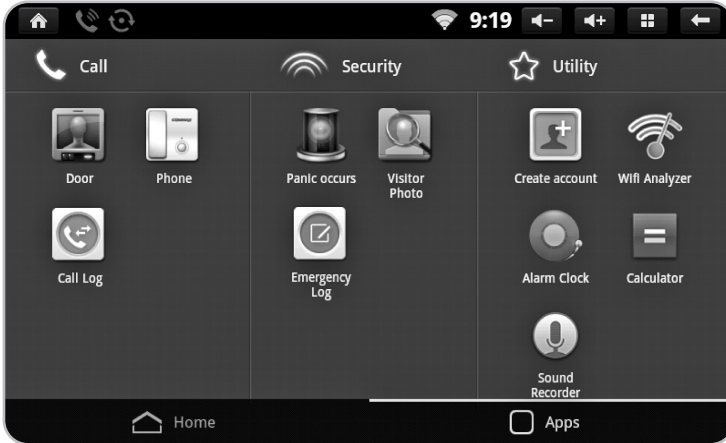

- 1) Touch an image that you wish to expand.
- 2) Touch  button at the top of the screen to view the previous.

5.3. Convenient features

5.3.1. Display composition



Convenient features

	Create account	User registration at 'Ruvie' (http://www.ruvie.co.kr/)
	Wifi Analyzer	Wifi Analyzer
	Alarm clock	Alarm clock
	Calculator	Calculator
	Sound recorder	Sound recorder



5.3.2. Create account

User registration

User registration



- 1) Touch 'Applications' icon.
- 2) Touch 'User registration' button.

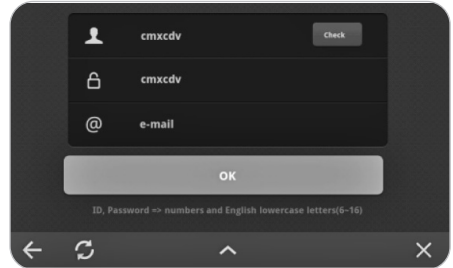

- 3) Enter your ID and touch 'ID check' button to check for validity.
- 4) Enter your password and email address and touch 'Confirm' button.

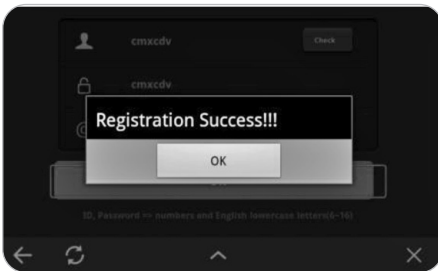

- 5) User registration is completed.

Renew information or set to factory default setting.

- 1) If already registered, the user information is displayed. Enter new information and touch 'renew' button to change information.
- 2) If 'Factory default setting' button is touched, the registered user information is deleted.

- ※ In order to make a call and/or check call log information via Smartphone, the user registration must be completed as explained above.
- ※ If the device is not connected to Internet, the user registration page is not activated.



5.3.3. Alarm clock

Alarm clock setting / activation

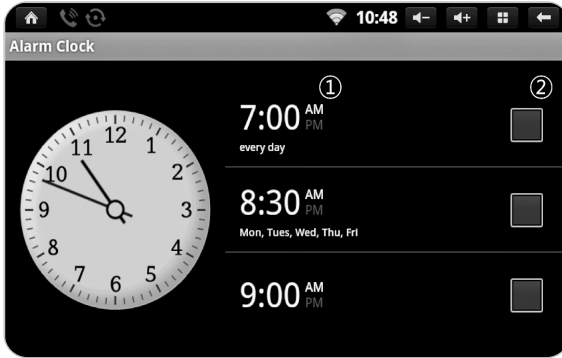

① List of alarm

② Activation button

Alarm clock

Time setting

- 1) Touch a time you wish to set up (①).
- 2) Touch the time to adjust.
- 3) After setting up an alarm, check the box on the right to activate the alarm.

Ringtone setting

- 1) Touch 'Ringtone'.
- 2) Check the ringtone for the alarm.
- 3) Touch 'Confirm' button to finish the setting.

Other settings

- 1) Select a repeat option.
- 2) Label the alarm.



5.3.4. Calculator

Only the four fundamental arithmetic operations are provided

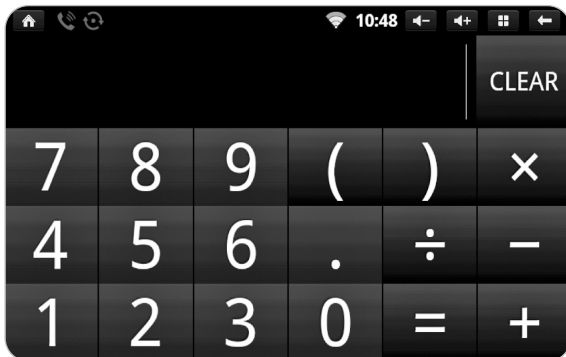

Calculator



5.3.5. Sound recorder

Voice recorder

Recording a voice message

- 1) Touch 'Record (①)' button.
- 2) Touch 'Stop (②)' button to stop recording and select 'Finish recording' to complete recording or 'Delete' to delete the message.
- 3) Touch 'Play (③)' button to listen to the recorded message.

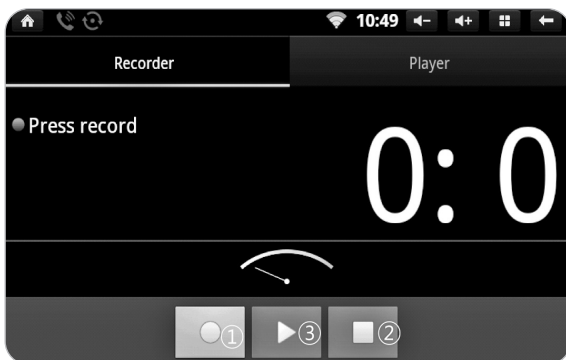

음성 녹음 화면



6. Settings

6.1. Settings

Update user information, network connection, language, time, etc.

- 1) Touch  (Other options) button at the top of Home page.
- 2) Touch 'Settings' button.



Settings

6.2. Password setting

Settings → COMMAX User Options → Change password

User can change the password to reset and off the Panic alert in this menu.

- 1) Touch 'Change password'
 - 2) Enter new password.
 - 3) Re-enter new password.
 - 4) Changing password is completed.
- ※ Default setting of password is 1234.

6.3. Advanced setting

Alert for wireless device connection

Settings → COMMAX User Options → Advanced setting → Alert for wireless device connection

Enabling alert for wireless device connection.

- 1) Check the box by a touch to activate the alert.
- 2) Uncheck the box to cancel.

Recording video of visitors

Settings → COMMAX User Options → Advanced setting → Recording video of visitors Enabling

recording video of visitors.

- 1) Check the box by a touch to activate the recording video.
- 2) Uncheck the box to cancel.

Select the video streaming quality

Settings → COMMAX User Options → Advanced setting → Streaming quality

Setting the video streaming quality for Smartphone.

- 1) Check the box by a touch to set 'High resolution'.
- 2) Uncheck the box to set 'Normal resolution'.

6.4. Wireless network setting

Wi-Fi On / Off

Settings → Wireless network → Wi-Fi

Check the box to turn on / off Wi-Fi.

Wi-Fi Setting

Settings → Wireless network → Wi-Fi setting

Available wireless network search, select, and connect.

Select an appropriate wireless network from the list of available wireless networks. Enter the password if required and touch 'Connect' button. Any available networks on the list with a lock require password.

Input other network

If the network you wish to connect is not found, direct input is allowed.

Select 'Add other network' at the bottom of the list.

Input Network SSID. Select network security type or EAP type and input password. The required information may vary depending on the network security type selection.

Undo Wi-Fi connection

Delete the selected network information from the list to avoid an automatic connection to the network.



Select the network you wish to delete and select 'Do not save'. The Wi-Fi connection will be disconnected and the connection information is initialized.

6.5. Sound setting

Mute mode setting

Settings → Sound → Mute mode

Changing to mute mode enabled (except for media and Alarm clock)

- 1) Touch 'Mute mode'.
- 2) If 'Mute mode' checked, the 'Sound setting' mode at the bottom of the screen is deactivated and  is displayed at the top of the screen.
- 3) If 'Mute mode' unchecked, the 'Sound setting' mode at the bottom of the screen is activated and  disappears from the top of the screen.

Ringtone (media) volume setting

Settings → Sound → Volume

- 1) Touch 'Volume'.
- 2) Move the bar to change the volume.
- 3) Touch 'Confirm' button to complete and save the volume setting.

Ringtone setting

Settings → Sound → Ringtone

- 1) Touch 'Ringtone'.
- 2) Ringtone for call function indicates the list of entrances
- 3) Touch the entrance you wish to set the ringtone and select the ringtone from the list (the 'Ringtone preview' available)
- 4) Touch 'Confirm' button to complete Ringtone setting.

6.6. Display setting

Brightness setting

Settings → Display → Brightness

- 1) Touch 'Brightness'.
- 2) Brightness setting page is displayed.
- 3) Move the bar to change the brightness.
- 4) Touch 'Confirm' button to complete and save the brightness setting.

Auto-display-off time setting

Settings → Display → off time

- 1) Touch 'Display off time'.
- 2) List of display time is displayed.
- 3) Touch the display time to save it or 'Cancel' button to deactivate.

Touch screen setting

Settings → Display → Touch screen setting

- 1) Touch 'Touch screen setting'.
- 2) Follow the instructions on the screen and touch '+' in order.
- 3) The message 'Touch screen setting is completed' is displayed.

Testing touch screen

Settings → Display → Touch screen test

- 1) Touch the 'Touch screen test' button.
- 2) The 'Touch screen test page' is displayed.
- 3) Press 'Home button (hardware button)' to return to Home.

6.7. Language and keyboard setting

Language setting

Settings → Language and keyboard → Language

Setting the displayed language of the device.

- 1) Touch 'Select language' button.
 - 2) Select the language from the list.
- ※ Supported language : Chinese, English, Korean

Keyboard setting

Select the keyboard.

6.8. Time and date setting

Settings → Time and date

Auto setting for time and date

- 1) Check 'Auto setting'.
- 2) The input screen for the time synchronization cycle with NTP server is displayed.
- 3) Touch 'NTP server' and enter the server address. The time of the device will be synchronized with the NTP server as scheduled.
- 4) The time on the device will be synchronized with the NTP server by the cycle set in '2'.

Manual setting for time and date

- 1) Uncheck 'Auto setting'.
- 2) Time and date setting is displayed.
- 3) Touch 'Date setting'.
- 4) Use '+' and '-' buttons to set the date and touch 'Confirm' button.
- 5) Touch 'Time setting'.
- 6) Use '+' and '-' buttons to set the time and touch 'Confirm' button.

Standard time setting

- 1) Touch 'Standard time'.
- 2) Select the standard time from the city listings.

24-Hour Time setting

- 1) Check '24-Hour Time' or uncheck.
- 2) If checked, the time will be displayed as in '24-Hour Time'.

Date type setting

- 1) Touch 'Date type'.
- 2) Available date types are displayed.
- 3) Select the type.

6.9. System information

System information including the components and firmware version information is displayed.

Components version

- 1) Touch 'Applications'.
- 2) The version information of installed components is displayed.

Firmware version

Boot loader and Kernel version including build number are displayed.



7. Supplement

7.1. The package includes the followings.

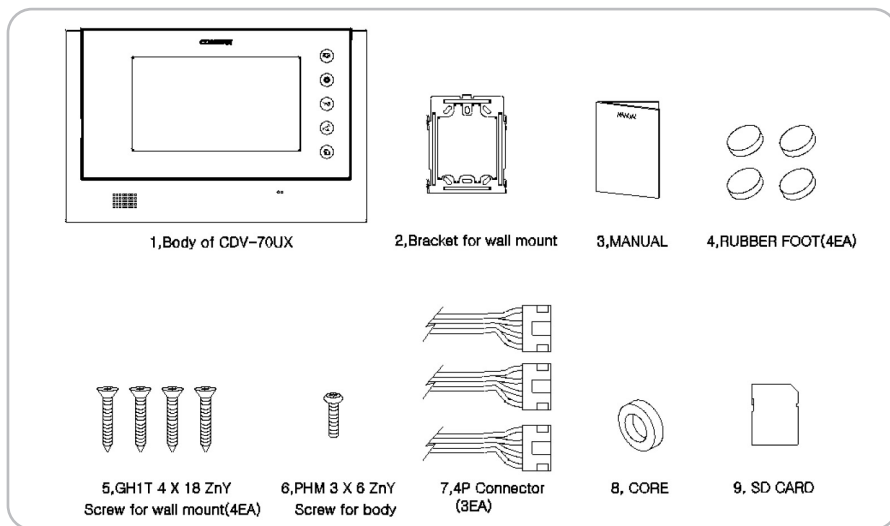

7.2. Specification and Features

Item	CDV-70UX
Wiring type	Individual entrance: Common 4-wire, Interphone: 4-wire
Power	100-240V~, 50~60Hz
Power	consumption Standby: 6W, Maximum: 12W
Communication method	HANDSFREE type VoIP
Ringtone	Individual entrance : Electronic chime with 3 tones
	(for 2 consecutive times)
	Interphone : Electronic bell
Effective range	Individual entrance: \varnothing 0.65 cable / 50m
Operating	temp. 0°C +40°C

7.3. Wiring

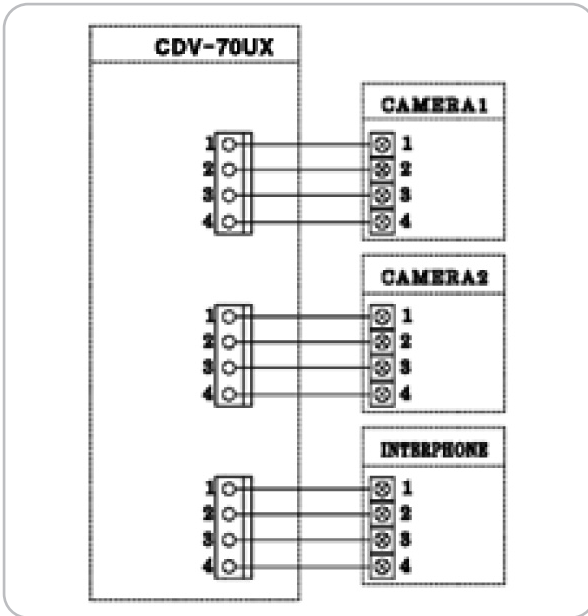

7.4. Caution for cabling

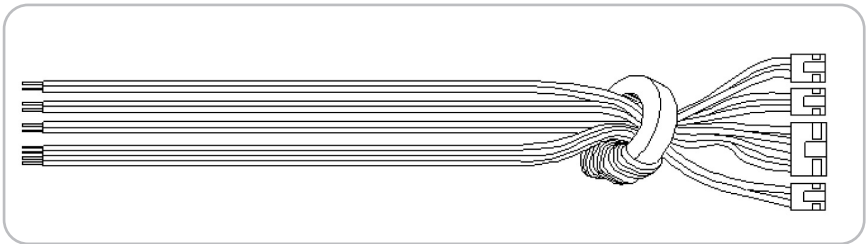

※ When wiring, please use the core provided in the package to wrap around as shown in the above.

7.5. Caution for recoding video of visitors

- ▶ Please do not replace or remove SD card while recording an image or video. It may cause a system error or losing recorded data.
- ▶ When the memory is full, automatic overwriting is activated and starts deleting the oldest image or video. It is recommended to back up the important images and/or videos.
- ▶ No images or videos will be recorded if there is no SD card inserted in the device.
- ▶ Please refer to the following list when you use SD card Proper recording functionality and quality are not guaranteed if any SD card is used other than the recommended memory cards listed below.

- 1) Manufacturer: Transcend
Micro SDHC: 8~32Gbyte
- 2) Manufacturer: SanDisk
Micro SDHC: 8~32Gbyte
- 3) Manufacturer: SAMSUNG
Micro SDHC: 8~32Gbyte
- 4) Manufacturer: SP (Silicon Power)
Micro SDHC: 8~32Gbyte

Caution for choosing wireless router

- ▶ UPNP must be supported.
(if UPNP not supported, the port-forwarding must be set manually)

Name	Port
FTP	21
TELNET	23
WEB	80
Control	29700, 29701, 29703, 29712, 30001
CAP	29732
PROXY	30128
MM, CVS	29720, 29740

7.6. Connecting via Smartphone

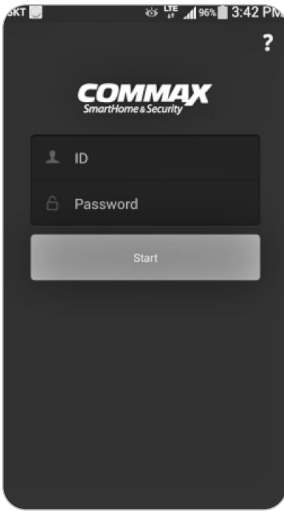

- 1) Execute 'commax' app.
- 2) Enter the same ID and Password registered at CDV-70UX and touch 'Log in' button.

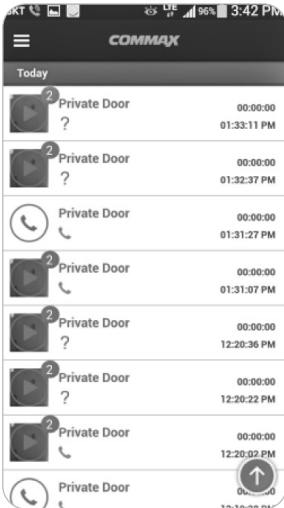

- 5) List of entrances

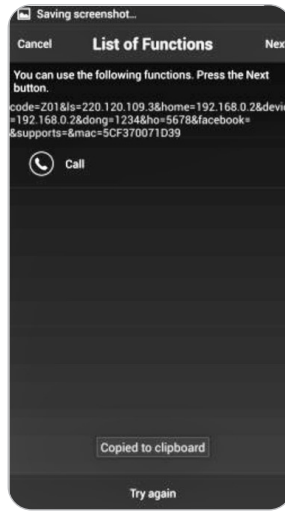

- 3) Read the user agreement and check the box to agree on the terms.
- 4) As connection is completed, function list is displayed. Touch 'Next'.



- 6) Touch 'Call' button to answer a call.
- 7) Touch 'Cancel' to reject a call.

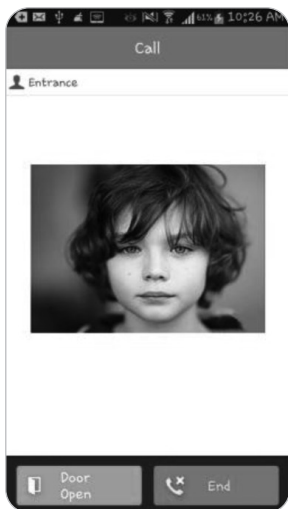

8) When connected, the corresponding entrance is viewed.



- 9) Touch 'Door release' button'. Read the warning message and touch 'Cancel' to cancel the door release.
- 10) Touch 'Confirm' to release the door.



Memo



Memo



Memo

COMMAX

COMMAX Co.,Ltd.

513-11, Sangdaewon-dong, Jungwon-gu, Seongnam-si, Gyeonggi-do, Korea

Int'l Business Dept. Tel. : +82-31-7393-540~550 Fax. : +82-31-745-2133

Web site : www.commax.com

PM0770UX0010

Printed In Korea / 2014.05.104