

Since 1968

**COMMAX**  
SmartHome & Security

# User Manual

COLOR VIDEO DOOR PHONE CDV-71AM



[www.commax.com](http://www.commax.com)

**COMMAX Co.,Ltd.**



- Thank you for purchasing COMMAX products.
- Please carefully read this User's Guide (in particular, precautions for safety) before using a product and follow instructions to use a product exactly.
- The company is not responsible for any safety accidents caused by abnormal operation of the product.



## 7. Specification

Item	Model	CDV-71AM
Wiring		CAMERA: 4wires, INTERPHONE 4wires, CCTV CAMERA 2wires
Power source		100-240V~, 50/60Hz (FREE VOLTAGE)
Power consumption		MAX : 15W, Stand-by : 3.4W
Image recording (CDV-71AM)		MAX 128 Cuts
Communication way		HANDS FREE type (Voice Switch)
Display		17.78Cm(7") COLOR TFT-LCD, Digital LCD
Call sound		COMMAX chime : 2 times Interphone : Electric chime
Video duration time		Stand-by :30 seconds, On the line : 60 seconds
Distance		Entrance: 50m (∅ 0.65) Interphone: 20m (∅ 0.65)
Operating temperature		0℃ ~ 40℃
Dimension		243X168X35mm



# Table of Contents

1. Product Overview .....	4
2. Operation Methods .....	5
3. Installation and wiring .....	14
4. Components .....	15
5. Trouble Shooting .....	16
6. Specification .....	17



# Warnings and caution

⦿ Make sure to follow the instructions to prevent any danger or property losses.



**Warning**  
Death or serious injury is expected.



It indicates prohibition.



It indicates prohibition of disassembly.



It indicates prohibition of contact.



It indicates dos and don'ts.



It indicates that the plug should be pulled out from the socket.



**Warning**

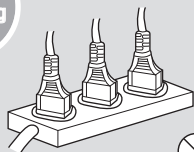

**Do not put the plug in the socket simultaneously.**  
It may generate abnormal heat or cause a fire.

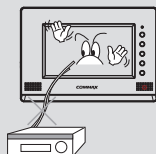

**Do not connect to other products while in use.**  
It may cause breakdown.

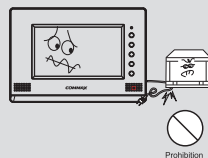

**Do not forcibly bend the cord or put a heavy object on the product.**  
It may cause a fire.

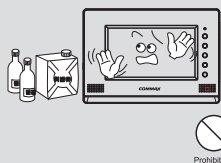

**Do not use water, thinner or a detergent used to wash oil products when you wash the exterior.**  
Make sure to wash it by using a dry cloth to prevent any breakdown or electric shock.

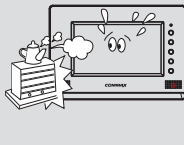

**Do not install the product in a humid place.**  
It may cause an electric shock or a fire.

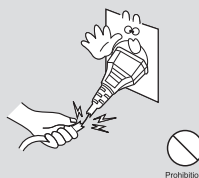

**Do not forcibly pull out the cord from the socket.**  
If the cord is damaged, it may cause a fire or an electric shock.



**Do not put the plug in the socket with a wet hand.**  
It may cause an electric shock.



**Do not disassemble, repair or modify the product.**  
It may cause a fire, an electric shock or an injury due to malfunction of the product.

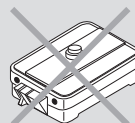

**Do not use AC circuit breaker.**  
It may cause an electric shock.

# Warnings and caution



**Caution** An injury or property losses are expected

- It indicates prohibition.
- It indicates prohibition of disassembly.
- It indicates prohibition of contact.
- It indicates dos and don'ts.
- It indicates that the plug should be pulled out from the socket.



**Caution**

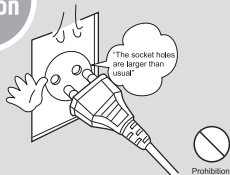

**If the socket holes are larger than normal, do not put the plug.**

It may cause an electric shock or a fire.



**Make sure that dust or foreign substances are not gathered on the product.**

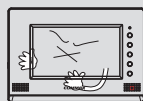

**Make sure to prevent foreign substances from entering the product.**

It may cause a breakdown.

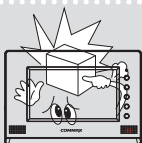

**Do not put a heavy object on the product.**

It may cause a breakdown.

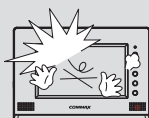

**Do not disassemble or give an impact to the product.**

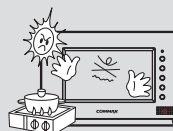

**Avoid direct rays of the sun or heating devices at a time of installation.**

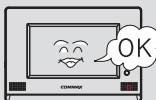

**Install the product in a flat and stable place.**

Otherwise, it may not function properly.



**Pull the plug if the product is not used for a long time.**

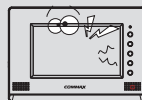

**If the product generates strange sound, make sure to pull the plug immediately and contact Commax service center.**



# 1. Product overview

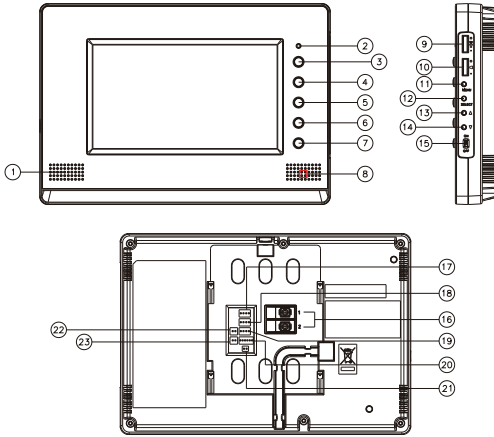

- ※ To display firmware version on the screen, press [▽] button
- ※ To reset to PAL mode, press the [Select] button and [▽] button at the same time.
- ※ To reset to NTSC mode, press the [Select] button and [△] button at the same time.

**Note :** When it is reset to PAL or NTSC, all saved data is deleted and language setting is changed as English

**Note :** When install CCTV camera, video standard(PAL or NTSC) must be same with installed door camera

No.	Description	No.	Description	No.	Description
1	Speaker	9	Volume control button	16	(N/A)
2	On/Off & display LED	10	Callingsoundlevel control button	17	CAMERA 1
3	Monitoring button	11	Menu switch	18	CAMERA 2
4	Interphone button	12	Camera mode select button (Related with No. 13.14)	19	Interphone
5	Talk button			20	Debug
6	Priority talk menu button	13~14	NTSC/PAL select & reset button	21	Camera 2_Use
7	Door release button			22	CCTV 1
8	Microphone	15	Power switch	23	CCTV 2

- ※ Volume control button: It is to adjust talking volume from counter side.
- ※ Calling sound level control button: It is to adjust calling sound
- ※ Screen resolution Button: Set the screen status at MENU -> GUI setting
- ※ Usage of camera 2(refer to no. 21 on above drawing): In order to use 2<sup>nd</sup> camera, jumper cap should be removed to activate no. 21 port.



**Note :** Only Camera 1 is available in factory default setting condition. In order to use camera 2, jumper cap should be removed to activate no. 21 port.





## 2. Operation Methods

### How to operate

#### ● Receiving a calling from visitor

1. When the call button is pressed by a visitor at the door camera, the melody shall be rung and visitors' image is shown on the screen.
2. Press "talk" button(  ) to talk with a visitor.  
(Maximum 60 seconds is available to talk on the phone.)
3. Press "talk" button(  ) again to close and return standby mode after finish the talk.
4. Press "door release" button (  ) to open the door while on the conversation.

#### ● Communication with a interphone

1. Press "talk" button (  ) and "interphone" button(  ) in sequence to make a conversation with the interphone connected with monitor.  
(It is available to talk on the phone for Maximum 60 seconds)
2. When receiving a call from an interphone, electrical sound shall be rung.  
Press "talk" button (  ) to start to talk.
3. When you receive a call from camera while talking with interphone, Visitor's image should be showed on the monitor.  
It shall be possible to talk between each unit, monitor, interphone and camera.

**Note :** When you finish talking with visitor or interphone, press "talk" button again to close the talk mode.

#### ● Monitoring.

(This is sample case of being installed 2 door cameras & 2 CCTV cameras. If it is not set like this, camera monitoring function shall not be deactivated.)

1. Press monitoring button (  ), appears camera image for 30 seconds.
2. Monitoring sequence (Screen will be changed by clicking the button in following sequence below)
  - 1) Camera 1 + CCTV1 (PIP mode)
    - a. Case 1: In case of no CCTV1 signal, screen will be switched to Camera 2 in full screen mode.
  - 2) Camera1 (Full screen)
  - 3) CCTV1 (Full screen)
    - a. In case of no CCTV1 signal, screen will be switched to Camera 4(camera 2+CCTV)

4) Camera 2 + CCTV2 (PIP mode)

- a. Case 1 : In case of jumper pin is set at "CA2\_USE"like picture no. 21, screen will be switched to Standby mode.
- b. Case 2 : In case of no CCTV2 signal, screen will be switched to camera5 in full screen mode.

5) Camera 2 (Full screen mode)---In case of camera2 & removed jumper pin like picture no.21

6) CCTV2 (Full screen mode)

- a. In case of no CCTV2 signal, switched to standby mode  
(In case of jumper pin is set at "CA2\_USE", CAM2 & CCTV2 are not activated.)

● **Priority talk( p» )**

When there is impeding noise that disturbs conversation from the door camera, pressing and holding the "PTT" button will deliver only the voice of the speaker from the CDV-71AM to the door camera unit to help clarify speech.

● **Recording visitors image**

- ※ Recording visitors' image. (Not apply to CCTV) Manual recording Press and hold the "monitoring" button (REC) for 1 second under " talk" or " monitoring" mode to save a cut of image with electric sound .Auto recording In auto recording mode, a cut of image is saved every time a visitor push the call button.

(Talk function is available by pressing talk button(  ) after finishing auto recording)

● **Function of icons**



display camera 1



display camera 2



display CCTV 1



display CCTV 2



## ● GUI functions

Press the “Menu” button, then the screen will be displayed like below.



Press the button beside each arrow to execute the function.

Touch menu is not support in this menu.



Display save images



Setup menu



Time setting menu



Display setting menu



Language setting menu



Save setting menu

● **Review recorded images**

Press the “Menu” button, then the screen display like below.



Buttons to turn 4 pages at a time



Button to select desirable screen



Button to switch to full-screen mode



: Next screen



: Previous screen



: Quad-screen view mode



: Delete current screen

(Image will be deleted after verifying pop-up menu)



Switch screen to previous menu.

(Press the “MEMU” button to move back to main screen)

## ● Setup

Setting menu : system configuration menu



Time setting menu



Display setting menu(Brightness, Contrast, Color)



Language setting.(Korean, English, Russian, Spanish, Persian, Turkish, Polish)



Save menu setting: Auto save, manual save, delete all saved images



Move to previous menu

## ● Time setting



Move to desirable sub-menu button  
(Year/Month/date/hour/minute)



Enter the desirable menu button



Adjusting time button



Move back to previous menu

(Press the "MEMU" button to exit this menu)

● Color adjustment



Select sub-menu on the screen

(Brightness/Contrast/Color)



Select desirable menu button



Adjust display button



Move back to previous menu button (Select subject again)



Configuration reset button



Move back to previous menu after finishing setting

( Color adjustment is not for CCTV but for door camera)

## ● Language setting

한국어	Korean	Корейский	Coreano	کره ای	Korece	Koreański
영어	English	Английский	Inglês	انگلیسی	İngilizce	Angielski
러시아어	Russian	Русский	Ruso	روسی	Rusca	Rosyjski
스페인어	Spanish	Испанский	Español	اسپانیایی	İspanyolca	Hiszpański
페르시아어	Persian	Китайский	Persa	فارسی	Farsça	Perski
터키어	Turkish	Турецкий	Turco	ترکی	Türkece	Turecki
폴란드어	Polish	Арабский	Arabe	عربی	Arapça	Polski

Korean / English / Russian / Spanish / Persian / Turkish / Polish selectable



Select language by clicking buttons



Save setting button



Move back to previous menu after finish setting

## ● Recording visitor's image (Auto / Manual)



Press the icon



Select Auto or Manual in recording method with buttons



Complete setting by pressing the button

Maximum 128 cuts can be saved

### 1. Auto record setting

In Auto record setting, every visitor image will be automatically recorded whenever door camera button being pressed by a visitor.

### 2. Manual record setting

In manual record setting, 1 cut of visitor's image will be recorded by being pressed the monitoring button(  ) on the monitor for 1 second.

( cf. This function is not applied to CCTV)

**Note** : It shall be set as a “ Auto Record” mode from manufacturer. When the visitors call, every visitor is automatically recorded 1 by 1. Maximum 128 cuts can be saved. In case 129th cut is recorded after 128th cuts, it should be replaced from existing 1st cuts (1/128) again.

### ● Deleting recorded images



Move back to save menu or delete all menu with buttons.



Move to setting menu

### ● Delete all



Select “Yes” or “No” by pressing the buttons



Select “Delete all” by pressing the buttons

(If “Yes” was selected, another window will appear for your reconfirmation)



Move back to previous menu

(Press the “MENU” button to move back to Standby mode)



## 4. Installation & wiring method.

### 1) Installation diagram

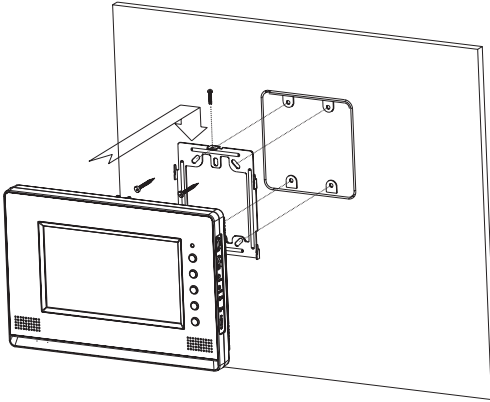

### 2) Installation location

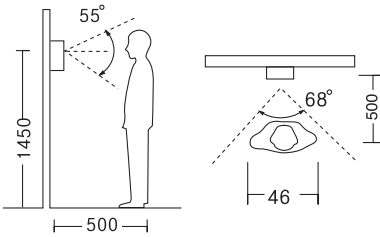

Unit : mm



## 2) Wiring diagram

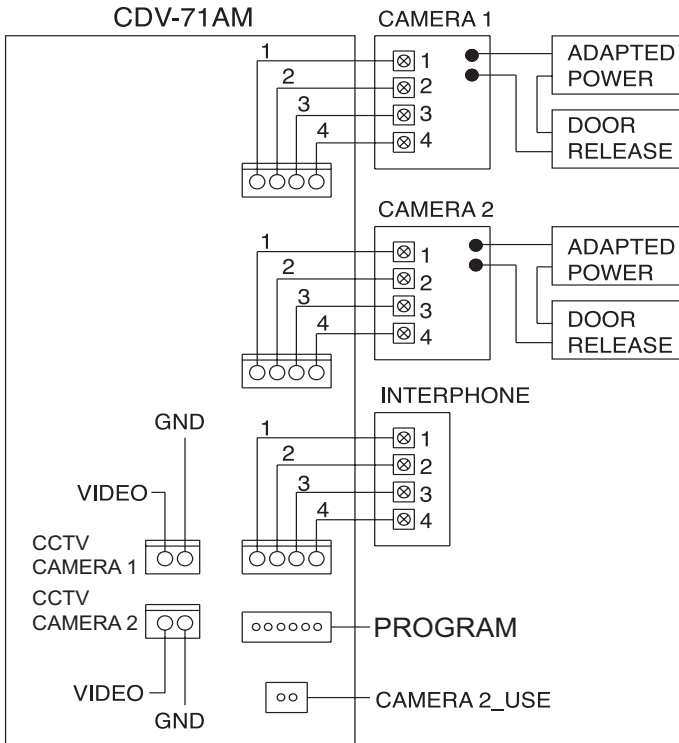

## 5. Components

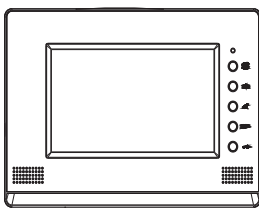

Monitor

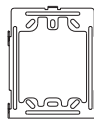

Wall bracket

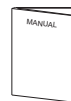

Manual



2P SHUNT

(Only No. 1 camera is available if you insert 2P shunt(short pin))

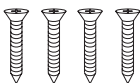

T4 X 18  
Wall bracket  
Mounting Screw



M3 X 6  
Monitor  
Fixing Screw

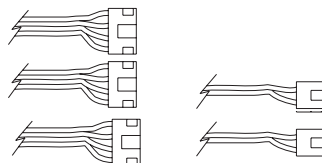

Connector  
(4P X 3pcs ,2P X 2pcs)



## 6. Trouble shooting.

If you think that the product has trouble, please first check below contents before you ask a repair.

Troubles	Check Point	Actions
<ul style="list-style-type: none"><li>• The power supply is not on.</li><li>• All works are stopped</li></ul>	<ol style="list-style-type: none"><li>1.The power supply cord is missing or not.</li><li>2.The power supply switch (down) is off or not.</li></ol>	<ol style="list-style-type: none"><li>1. Please connect the power supply cord</li><li>2. Please turn on the power supply switch (down) pushing to the right.</li></ol>
<ul style="list-style-type: none"><li>• A Call operation is not performed. (Door, Interphone function)</li></ul>	<ol style="list-style-type: none"><li>1.The wiring between other units is connected correctly in good order or not.</li><li>2. The wiring is missing or not.</li></ol>	<ol style="list-style-type: none"><li>1. Please refer to connection related page and manage.</li><li>2. Please connect correctly to the terminal.</li></ol>
<ul style="list-style-type: none"><li>• The product does not produce the sound. (Call volume, Talk volume)</li></ul>	<ol style="list-style-type: none"><li>1. A sound volume lies in minimum or not.</li></ol>	<ol style="list-style-type: none"><li>1. Please adjust the sound volume properly turning to the up, as you want.</li></ol>
<ul style="list-style-type: none"><li>• The screen is dark.</li><li>• The screen is strange.</li></ul>	<ol style="list-style-type: none"><li>1. There is a strong reflected light behind the visitor or not.</li><li>2. The screen control is adjusted correctly.</li></ol>	<ol style="list-style-type: none"><li>1. Please change the angle of camera lens.</li></ol>

# **COMMAX**

**COMMAX Co.,Ltd.**

513-11, Sangdaewon-dong, Jungwon-gu, Seongnam-si, Gyeonggi-do, Korea

Int'l Business Dept. Tel. : +82-31-7393-540~550 Fax. : +82-31-745-2133

Web site : [www.commax.com](http://www.commax.com)

PM0771AM0011

Printed In Korea / 2011.10.104