

DCU - User Manual

The DCU unit is a Multi function device designed for DT system to connect 2 CCTV cameras and control light or lock(One light and one lock can be supported in the system, and they must be connected to two separate DCUs). Note that this unit can only be used in the DT intercom system.

- Supply power to the Camera directly.
- Two different lock control mode: Normally Closed Mode and Normally Open Mode.
- Two different light control mode: Delay Mode and Trigger Mode, and light-on-by-calling function is available.
- Unlock time or Light delay time set by DIP switches.
- Can be cascaded up to 3 units to control up to 6 Cameras.

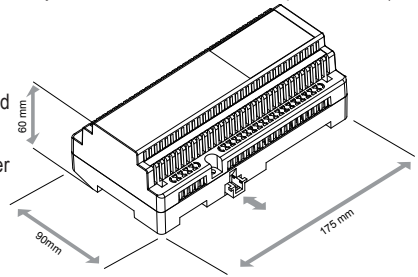

1. Terminal Descriptions

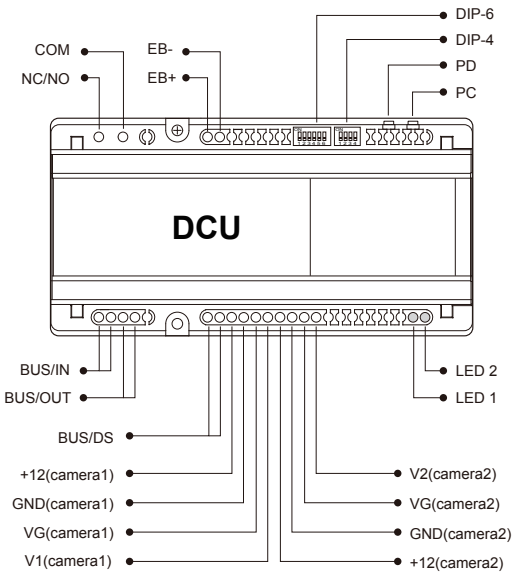

- **COM:** Contact relay Common terminal
- **NC/NO:** Contact relay Normally-Closed / Normally-Opened terminal
- **EB+, EB-:** Contact activate button
- **DIP-6:** Main DIP switches
- **DIP-4:** Switches for Lock/Light control
- **PC:** Repeated Code Checking, if there are repeated Code setting on all the DCUs and Doorstations, the LED1 and LED 2 will flashing for 10 seconds
- **PD:** Video test button, press this button, the Doorstation will call the Monitor with User Code 01, and output the Video from Camera1.
- **BUS/IN, BUS/OUT:** Connect to the Bus Line
- **BUS/DS:** Connect to Door Station
- **LED1:** Lock/Light indicator
- **LED2:** Power/Video signal indicator
- **+12:** Power+ for CCTV camera
- **GND:** Power- for CCTV camera
- **VG:** Video Ground for CCTV camera
- **V1, V2:** Video Core for CCTV camera









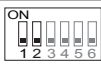

2. Specifications

- **Power Consumption:** 0.25W in standby, 0.5 W in acting
- **NC/NO, COM exchange contact:** 250V ac 7A
- **Monostable relay activation time:** adjustable from 1 second to 10 minutes $\pm 5\%$
- **Working temperature:** -5°C $+45^{\circ}\text{C}$
- **CCTV Power Output 1:** 12V 500mA
- **CCTV Power Output 2:** 12V 500mA
- **Input Frequency:** 47~63 Hz
- **Leakage Current:** $>2\text{mA}$ / 240Vac

3. DIP switches settings



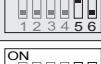

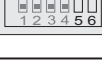



DIP-6 settings: The DIP-6 switches are for DCU Code and Camera control settings.

- DCU Code: A unique identification of the device(range from 1~3), it has the same Code level as Doorstation. Total 4 Doorstation or 3 DCUs(plus one Doorstation) can be installed in one system; for example, if 2 DCUs are installed, maximum 2 Doorstations can be installed to the system.
- Bit-1 and Bit-2: DCU Code setting. Note that the DCU can not be set to Master(Bit-1 = Bit-2 = **OFF**). Only one Doorstation can be set to Master.
- Bit-3: Light control mode / Unlock mode setting:
 - » When control a light, set to **ON** to enable the light-on-by-calling function: the light will automatically turned on when the visitor calls from the Doorstation; set to **OFF** to disable this function;
 - » When control a lock, set to **ON** to select Normally Closed unlock mode, set to **OFF** to select Normally Open unlock mode.
- Bit-4: Camera quantity setting. If connect 1 CCTV camera, set to **ON**; set to **OFF** for 2 CCTV cameras. Multiple DCU must be used when more than 2 CCTV cameras needed to be connected.
- Bit-5 and Bit-6: Switching time between the 2 CCTV cameras(if connected 2 cameras), this setting become invalid when only one CCTV camera connected.

Bit definition	Bit state	Function Descriptions
Bit-1 and bit-2 DCU Code setting		Invalid for DCU.
		set to the First DCU.
		set to the Second DCU.
		set to the Third DCU.
Bit-3 Light control or unlock mode setting		1. When connect a light, disable light-on-by-calling; 2. When connect a lock, select Normally Open mode.
		1. When connect a light, enable light-on-by-calling; 2. When connect a lock, select Normally Closed mode.
Bit-4 Camera quantity setting		Connect 2 CCTV cameras to this DCU.
		Connect only one CCTV camera to this DCU.
Bit-5 and bit-6 Switching time setting		Switching time = 5 second.
		Switching time = 10 seconds.
		Switching time = 15 seconds.
		Switching time = 20 seconds.

DIP-4 settings: The DIP-4 switches are for Light / Lock control settings.

- Bit-1 and Bit-2: Control Mode setting. There are four different settings
 - » When no light or lock connected, set Bit-1 = Bit-2 = **OFF**;
 - » When connect a electronic lock, set Bit-1 = **ON**, Bit-2 = **OFF**;
 - » When connect a light, and use the Delay Mode, set Bit-1 = **OFF**, Bit-2 = **ON**;
 - » When connect a light, and use the Trigger Mode, set Bit-1 = **ON**, Bit-2 = **ON**.
- Delay Mode and Trigger Mode:
 - » Delay Mode: the light will be automatically turned off after a specified period of time(can be set to 1, 3, 5 or 10 minutes by the Bit-3 and Bit-4 switches);
 - » Trigger Mode, the light will be turned on and off manually by the Light Button or the screen.
- Bit-3 and Bit-4: Light delay time or Unlock time setting.
 - » When connect a light, 1, 3, 5 or 10 minutes delay time can be choosen, this setting will be invalid when the Control Mode is set to Trigger Mode(Bit-1 = **ON**, Bit-2 = **ON**).
 - » When connect a lock, 1, 3, 5 or 10 seconds unlock time can be shosen.

Bit definition	Bit state	Function Descriptions
Bit-1 and bit-2 Control Mode setting		Do not control any light or lock.
		lock control.
		light control with Delay Mode.
		light control with Trigger Mode.
Bit-3 and Bit-4 Light Delay time or Unlock time setting		10 minutes light delay time or 10 seconds unlock time
		5 minutes light delay time or 5 seconds unlock time
		3 minutes light delay time or 3 seconds unlock time
		1 minutes light delay time or 1 seconds unlock time

4. Mounting

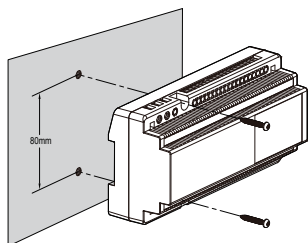

Mounting method 1: Direct mounting. use two screws to fix the DCU on the wall Directly

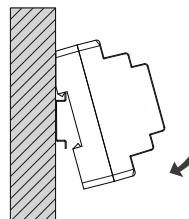

Mounting method 2: DIN nail mounting. Slot the DCU on the DIN nail.

5. Terminal Connections

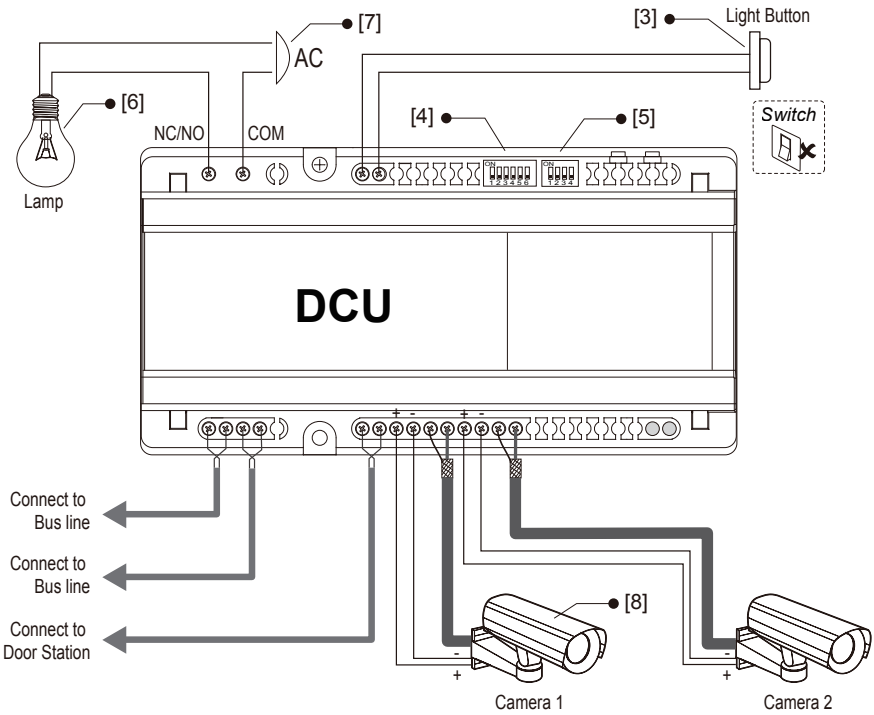
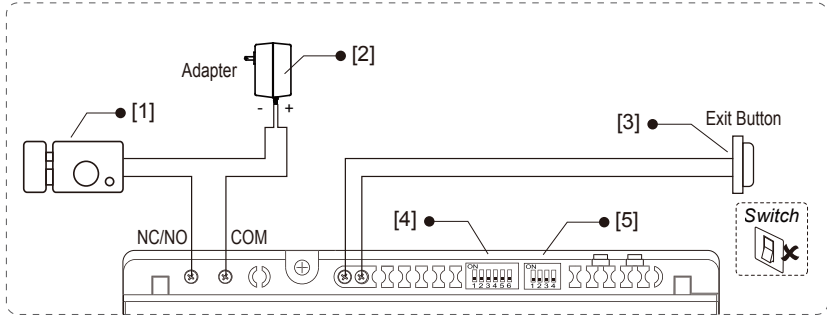

Connect to Bus line
 Connect to Bus line
 Connect to Door Station

- [1] When connect a electroic lock, set Bit-1 = **ON**, Bit-2 = **OFF** of DIP-4 to select lock control. If the lock is a Power-on-to-Unlock type, set Bit-3 = **OFF** of the DIP-6 to select Normally Open mode), set Bit-3 = **ON** to select Normally Closed mode when connect a Power-Off-to-Unlock type.
- [2] Please use the correct adapter for the lock.
- [3] Please connect with the Button, do not connect with a switch.

- [4] DIP-6 switches, must be set correctly.
- [5] DIP-4 switches, must be set correctly.
- [6] When connect a light, set Bit-1 = **OFF**, Bit-2 = **ON** or Bit-1 = **ON**, Bit-2 = **ON** of DIP-4 to select one of the light control mode.
- [7] Connect to AC electricity from 100~250V.
- [8] CCTV camera, the rated power of the camera must less than 12V 500mA.

6. Standard Connection

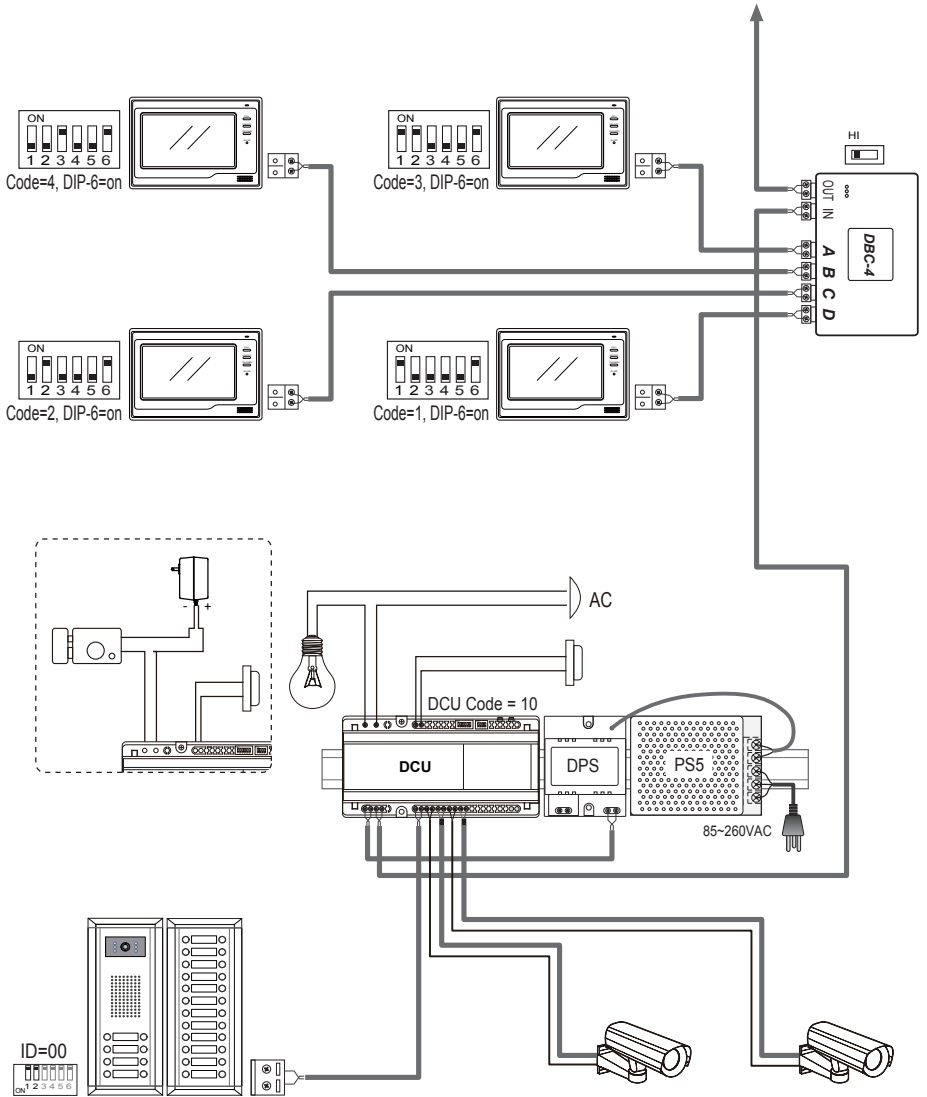

7. One Doorstation and Three DCU Connection

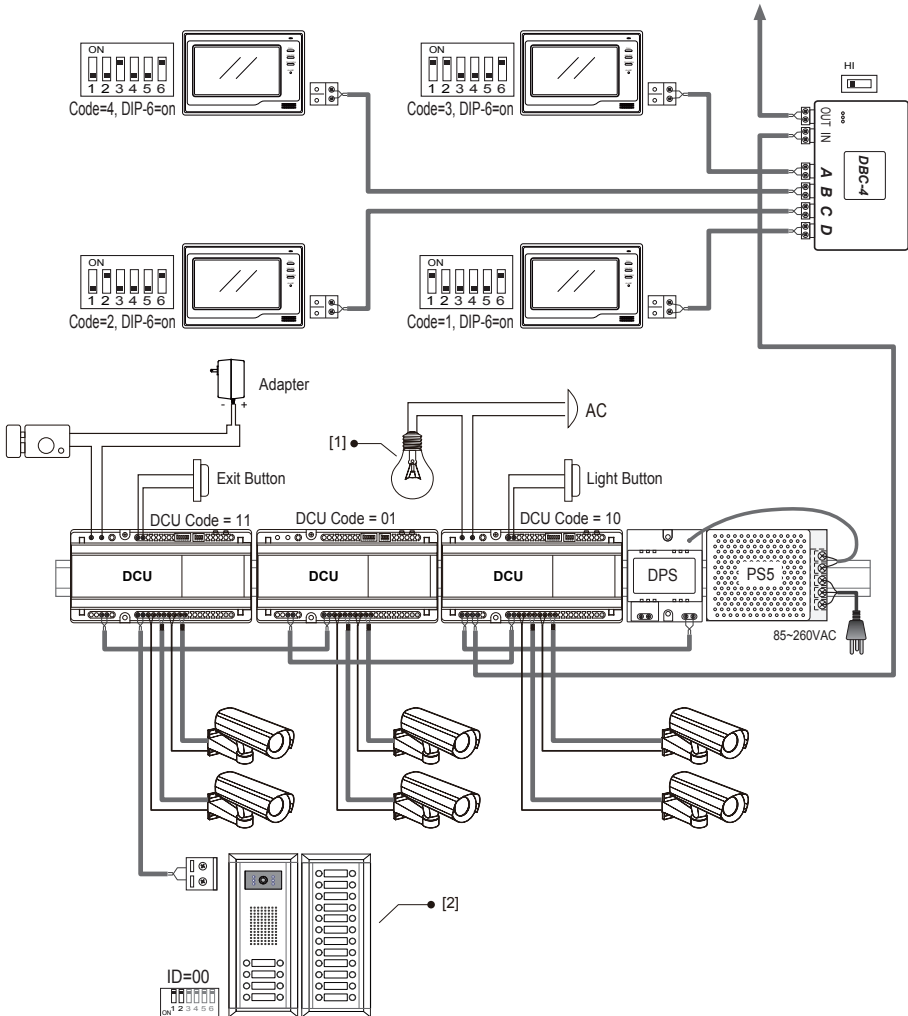

[1] Only one DCU can be connected with a lock or light in the system.

[2] Only one Doorstation can be connected when using

3 DCU units, and the Doorstation must be connected to the DCU which is the farthest to the DPS unit. And the Doorstation must be set to Master(ID=00)

8. Two Doorstations and Two DCUs connection

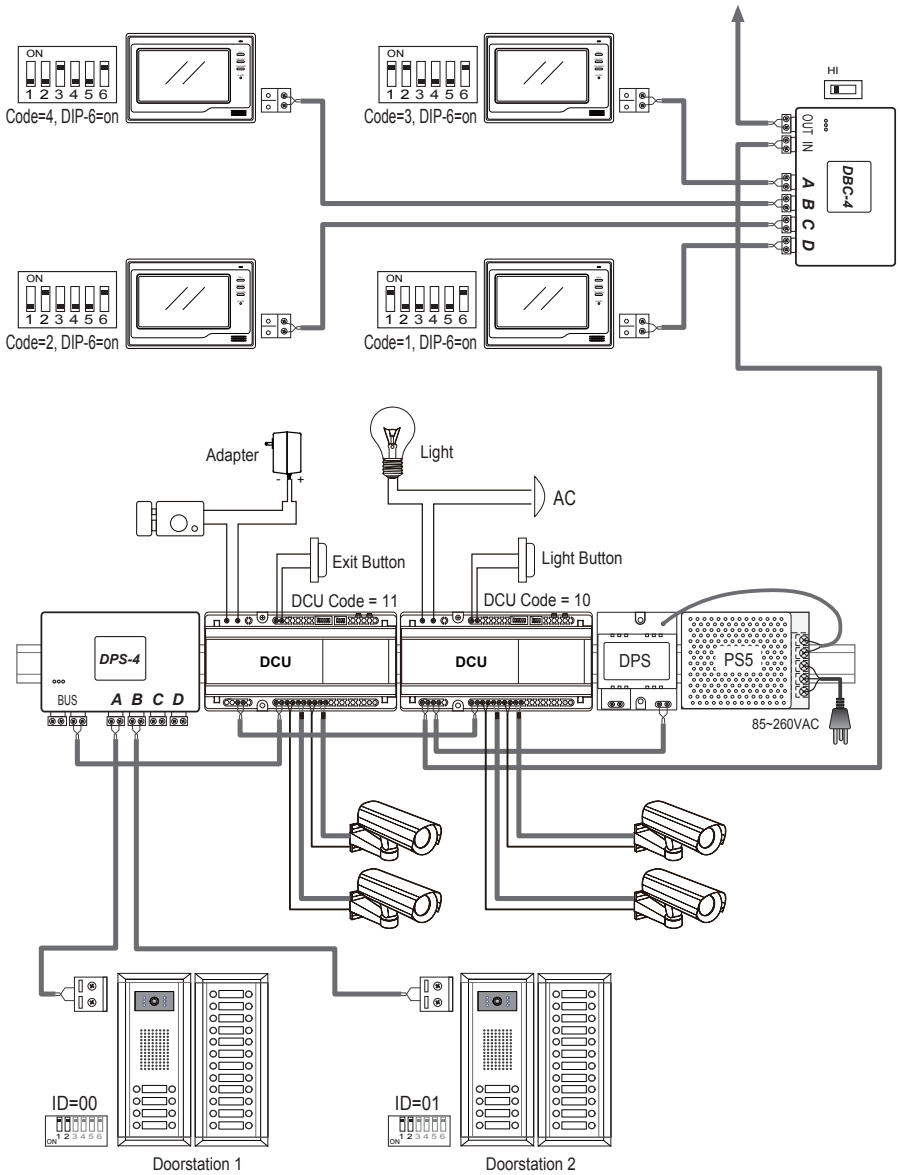

9. Three Doorstations and One DUC Connection

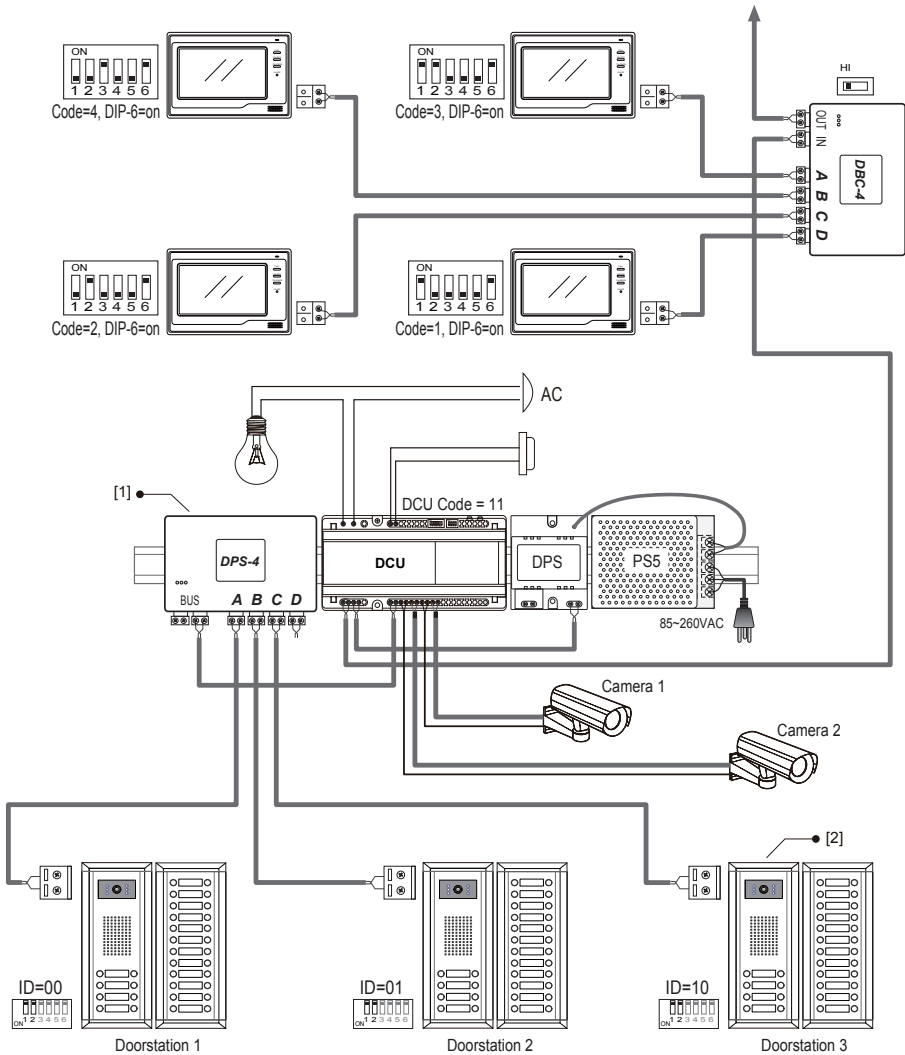

[1] Extending Doorstations by DPS-4 unit.

[2] Maximum 3 Doorstations can be connected when using one DCU unit

The design and specifications can be changed without notice to the user. Rights to interpret and copyright of this manual are preserved.