



BASIC

Series 1 & 2

Basic electric strikes are ideal for simple ironmongery installations, such as **home door phones**. They are available with fixed or adjustable keeper, for either DIN right or left doors.

Featuring a wide variety of functions and voltages, these strikes quickly unlock standard doors through low power consumption.

Technical features

- Guaranteed endurance rating: 300.000 cycles (120N side-load on AC)
Max. side-load on AC: 160 N
Max. side-load on DC: 10 N
- Break-in resistance: 4.000 N
- Operating temperature range: -15 °C /+40 °C
- Housing Material: Zamak
- Keeper Material: Zamak
Keeper's Adjustability: 3 mm
Fixed Keeper Depth: 8,25 mm
Adjustable Keeper Depth: 7,75 mm
- Guaranteed 3 years
- Complies with 2004/108/CE (EN 55014)
- Corrosion resistant according to UNI ISO 9227

Coil features

- | | |
|---|---|
| B 8-14 V ac/dc <1min
(12 Ω 0,8A at 12 V ac) | J 5-12 V ac/dc <1min
(8 Ω 0,9A at 9 V ac) |
| E 12 V dc ∞
(60 Ω 0,20A) | F 24 V dc ∞
(220 Ω 0,12A) |

Special coils available upon request:

- | | | |
|------------------------|---------------------------|----------------------------|
| C 12 V ac <1min | T1 6-14 V ac <1min | T2 15-24 V ac <1min |
|------------------------|---------------------------|----------------------------|

References and features

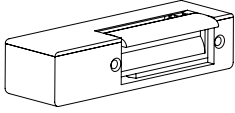
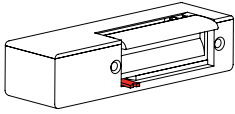
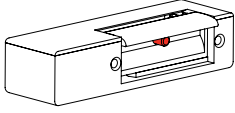
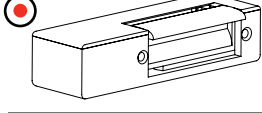
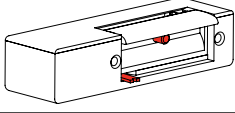
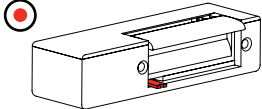
	Fixed keeper	Adjustable keeper	Side-load	Voltage	References DIN right add faceplate	References DIN left add faceplate
 Fail-secure	•		•	8-14 V ac/dc	10.0.00.B	20.0.00.B
	•		•	5-12 V ac/dc	10.0.00.J	20.0.00.J
	•			12 V dc	10.0.00.E	20.0.00.E
	•			24 V dc	10.0.00.F	20.0.00.F
 Fail-secure with mechanical unlocking	•		•	8-14 V ac/dc	11.0.00.B	21.0.00.B
	•		•	5-12 V ac/dc	11.0.00.J	21.0.00.J
	•			12 V dc	11.0.00.E	21.0.00.E
	•			24 V dc	11.0.00.F	21.0.00.F
 Hold-open	•		•	8-14 V ac/dc	12.0.00.B	22.0.00.B
	•		•	5-12 V ac/dc	12.0.00.J	22.0.00.J
		•	•	8-14 V ac/dc	12.1.00.B	22.1.00.B
		•	•	5-12 V ac/dc	12.1.00.J	22.1.00.J
 Internal Hold-open	•		•	9-14 V ac/dc	12A.0.00.B	22A.0.00.B
	•		•	6-12 V ac/dc	12A.0.00.J	22A.0.00.J
		•	•	9-14 V ac/dc	12A.1.00.B	22A.1.00.B
		•	•	6-12 V ac/dc	12A.1.00.J	22A.1.00.J
 Hold-open with mechanical unlocking	•		•	8-14 V ac/dc	13.0.00.B	23.0.00.B
	•		•	5-12 V ac/dc	13.0.00.J	23.0.00.J
		•	•	8-14 V ac/dc	13.1.00.B	23.1.00.B
		•	•	5-12 V ac/dc	13.1.00.J	23.1.00.J
 Internal Hold-open with mechanical unlocking	•		•	9-14 V ac/dc	13A.0.00.B	23A.0.00.B
	•		•	6-12 V ac/dc	13A.0.00.J	23A.0.00.J
		•	•	9-14 V ac/dc	13A.1.00.B	23A.1.00.B
		•	•	6-12 V ac/dc	13A.1.00.J	23A.1.00.J

Recommended Faceplates

SHORT	LONG	ANGLED
01 Grey	03 Grey Brown	08 Brown
61 SST	04 Grey Brown	09 Brown
66 SST	05 Grey Brown	10 Brown
	20 SST	11 Brown
BOX	21 SST	12 Brown
80 Grey	43 SST	13 Brown
81 Grey	63 SST	14 Brown
84 Grey	64 SST	15 Brown
Chrome	65 SST	16 Brown
Brass	67 SST	17 Brown
	73 SST	
	74 SST	
	C63 SST	
	C64 SST	
	C65 SST	
	D3 Grey Brown	
	D4 Grey Brown	

Dimensions

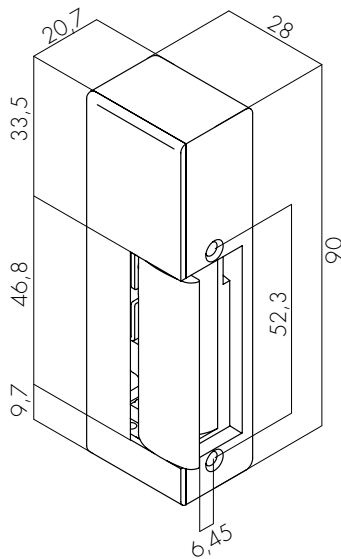

Available keepers

Deep adjustable keeper
Supplied upon request

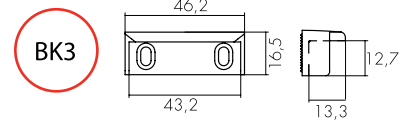

Shim kit for BK3

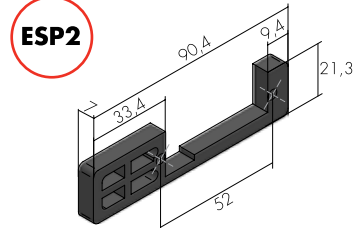

Shallow adjustable keeper
Supplied upon request

